

ENGINE CONTROL (3VZ-E)

SYSTEM OUTLINE

THE ENGINE CONTROL SYSTEM UTILIZES A MICROCOMPUTER AND MAINTAINS OVERALL CONTROL OF THE ENGINE, TRANSMISSION, ETC. AN OUTLINE OF ENGINE CONTROL IS GIVEN HERE.

1. INPUT SIGNAL

(1) ENGINE COOLANT TEMP. (WATER TEMP.) SIGNAL SYSTEM

THE ENGINE COOLANT TEMP. SENSOR (EFI WATER TEMP. SENSOR) DETECTS THE ENGINE COOLANT TEMP. AND HAS A BUILT-IN THERMISTOR WITH A RESISTANCE WHICH VARIES ACCORDING TO THE ENGINE COOLANT TEMP. (WATER TEMP.) THUS THE ENGINE COOLANT TEMP. (WATER TEMP.) IS INPUT IN THE FORM OF A CONTROL SIGNAL TO **TERMINAL THW** OF THE ENGINE CONTROL MODULE (ECU).

(2) INTAKE AIR TEMP. SIGNAL SYSTEM

THE INTAKE AIR TEMP. SENSOR IS INSTALLED INSIDE THE VOLUME AIR FLOW (AIR FLOW METER) AND DETECTS THE INTAKE AIR TEMP., WHICH IS INPUT AS A CONTROL SIGNAL TO **TERMINAL THA** OF THE ENGINE CONTROL MODULE (ECU).

(3) OXYGEN SENSOR SIGNAL SYSTEM

THE OXYGEN DENSITY IN THE EXHAUST EMISSIONS IS DETECTED AND INPUT AS A CONTROL SIGNAL TO **TERMINALS OX1** AND **OX2** OF THE ENGINE CONTROL MODULE (ECU). TO MAINTAIN STABLE DETECTION PERFORMANCE BY THE OXYGEN SENSOR, A HEATER IS USED FOR WARMING THE SENSOR. THE HEATER IS ALSO CONTROLLED BY THE ENGINE CONTROL MODULE (ECU) (HT1, HT2).

(4) RPM SIGNAL SYSTEM

CRANKSHAFT POSITION AND ENGINE RPM ARE DETECTED BY THE PICK-UP COIL INSTALLED INSIDE THE DISTRIBUTOR. CRANKSHAFT POSITION IS INPUT AS A CONTROL SIGNAL TO **TERMINALS G1** AND **G2** OF THE ENGINE CONTROL MODULE (ECU), AND RPM IS INPUT TO **TERMINAL NE**.

(5) THROTTLE SIGNAL SYSTEM

THE THROTTLE POSITION SENSOR DETECTS THE THROTTLE VALVE OPENING ANGLE, WHICH IS INPUT AS A CONTROL SIGNAL TO **TERMINAL VTA** OF THE ENGINE CONTROL MODULE (ECU), OR WHEN THE VALVE IS FULLY CLOSED, TO **TERMINAL IDL**.

(6) VEHICLE SPEED SIGNAL SYSTEM

THE VEHICLE SPEED SENSOR (SPEED SENSOR), INSTALLED INSIDE THE COMBINATION METER, DETECTS THE VEHICLE SPEED AND INPUTS A CONTROL SIGNAL TO **TERMINAL SPD** OF THE ENGINE CONTROL MODULE (ECU).

(7) A/C SW SIGNAL SYSTEM

THE OPERATING VOLTAGE OF THE A/C MAGNETIC CLUTCH IS DETECTED AND INPUT IN THE FORM OF A CONTROL SIGNAL TO **TERMINAL A/C** OF THE ENGINE CONTROL MODULE (ECU).

(8) BATTERY SIGNAL SYSTEM

VOLTAGE IS CONSTANTLY APPLIED TO **TERMINAL BATT** OF THE ENGINE CONTROL MODULE (ECU). WHEN THE IGNITION SW IS TURNED ON, VOLTAGE FOR ENGINE CONTROL MODULE (ECU) OPERATION IS APPLIED VIA THE EFI MAIN RELAY TO **TERMINAL +B** OF THE ENGINE CONTROL MODULE (ECU).

(9) INTAKE AIR VOLUME SIGNAL SYSTEM

INTAKE AIR VOLUME IS DETECTED BY THE POTENTIOMETER INSTALLED INSIDE THE VOLUME AIR FLOW (AIR FLOW METER) AND IS INPUT AS A CONTROL SIGNAL TO **TERMINAL VS** OF THE ENGINE CONTROL MODULE (ECU). INSIDE THE VOLUME AIR FLOW (AIR FLOW METER) THERE IS ALSO A SW FOR FUEL PUMP OPERATION, AND WHEN THE MEASURING PLATE OPENS (AIR INTAKE OCCURS), THIS SW TURNS ON AND CURRENT FLOWS TO THE FUEL PUMP TO OPERATE IT.

(10) STOP LIGHT SW SIGNAL SYSTEM

THE STOP LIGHT SW IS USED TO DETECT WHETHER OR NOT THE VEHICLE IS BRAKING AND THE INFORMATION IS INPUT AS A CONTROL SIGNAL TO **TERMINAL STP** OF THE ENGINE CONTROL MODULE (ECU).

(11) STA SIGNAL SYSTEM

TO CONFIRM THAT THE ENGINE IS CRANKING, THE VOLTAGE APPLIED TO THE STARTER MOTOR DURING CRANKING IS DETECTED AND IS INPUT AS A CONTROL SIGNAL TO **TERMINAL STA** OF THE ENGINE CONTROL MODULE (ECU).

(12) ENGINE KNOCK SIGNAL SYSTEM

ENGINE KNOCKING IS DETECTED BY THE KNOCK SENSOR AND INPUT AS A CONTROL SIGNAL TO **TERMINAL KNK** OF THE ENGINE CONTROL MODULE (ECU).

(13) 4WD SIGNAL SYSTEM

WHETHER OR NOT THE VEHICLE IS OPERATING IN 4WD MODE IS DETERMINED, AND A CONTROL IS INPUT TO **TERMINAL 4WD** OF THE ENGINE CONTROL MODULE (ECU).

2. CONTROL SYSTEM

* MFI (MULTIPOINT FUEL INJECTION) (EFI) SYSTEM

THE MFI (EFI) SYSTEM MONITORS THE ENGINE CONDITIONS THROUGH THE SIGNALS EACH SENSOR (INPUT SIGNALS (1) TO (11), (13)) INPUTS TO THE ENGINE CONTROL MODULE (ECU). BASED ON THIS DATA AND THE PROGRAM MEMORIZED IN THE ENGINE CONTROL MODULE (ECU), THE MOST APPROPRIATE FUEL INJECTION TIMING IS DECIDED AND CURRENT IS OUTPUT TO **TERMINAL #10** AND **#20** OF THE ENGINE CONTROL MODULE (ECU). CAUSING THE INJECTORS TO OPERATE (TO INJECT FUEL). IT IS THIS SYSTEM WHICH, THROUGH THE WORK OF THE ENGINE CONTROL MODULE (ECU), FINELY CONTROLS FUEL INJECTION IN RESPONSE TO DRIVING CONDITIONS.

* ESA (ELECTRONIC SPARK ADVANCE) SYSTEM

THE ESA SYSTEM MONITORS THE ENGINE CONDITIONS USING THE SIGNALS (INPUT SIGNALS (1, 4, 5 TO 7, 9, 11, 12)) INPUT TO THE ENGINE CONTROL MODULE (ECU) FROM EACH SENSOR. BASED ON THIS DATA AND THE PROGRAM MEMORIZED IN THE ENGINE CONTROL MODULE (ECU), THE MOST APPROPRIATE IGNITION TIMING IS DECIDED AND CURRENT IS OUTPUT TO **TERMINAL 1GT** OF THE ENGINE CONTROL MODULE (ECU). THIS OUTPUT CONTROLS THE IGNITER TO PRODUCE THE MOST APPROPRIATE IGNITION TIMING FOR THE DRIVING CONDITIONS.

* FUEL PRESSURE-UP SYSTEM

THE FUEL PRESSURE UP SYSTEM CAUSES THE VSV (FOR FUEL PRESSURE UP, A/C IDLE-UP) TO COME ON FOR HIGH TEMP. STARTS AND FOR ABOUT **180** SECONDS AFTER STARTING IN ORDER TO INCREASE THE FUEL PRESSURE, IMPROVE STARTABILITY AT HIGH TEMPERATURES AND PROVIDE STABLE IDLING. THE ENGINE CONTROL MODULE (ECU) EVALUATES THE INPUT SIGNALS FROM EACH SENSOR (1-1, 1-2, 2, 4 AND 11)), OUTPUT CURRENT TO **TERMINAL FPU** AND CONTROLS THE VSV. (HOWEVER, WHEN THE ENGINE COOLANT TEMP. (WATER TEMP.) IS **95° C, 203° F** MORE AND THE INTAKE AIR TEMP. IS **55° C, 131° F** FOR MORE, THE VSV (FOR FPU) INCREASES THE FUEL PRESSURE FOR **90** SECOND.)

* OXYGEN SENSOR HEATER CONTROL SYSTEM

THE OXYGEN SENSOR HEATER CONTROL SYSTEM TURNS THE HEATER TO ON WHEN THE INTAKE AIR VOLUME IS LOW (TEMP. OF EXHAUST EMISSIONS LOW), AND WARMS UP THE HEATED OXYGEN SENSOR (OXYGEN SENSOR) TO IMPROVE DETECTION PERFORMANCE OF THE SENSOR. THE ENGINE CONTROL MODULE (ECU) EVALUATES THE SIGNALS FROM EACH SENSOR (INPUT SIGNALS (1, 4, 8, 9, 11)), CURRENT IS OUTPUT TO **TERMINALS HT1** AND **HT2** AND CONTROLS THE HEATER.

* PAIR CONTROL SYSTEM

THE PAIR CONTROL SYSTEM TURNS ON THE VSV (FOR PAIR) WHEN THE ENGINE IS COLD AND DURING DECELERATION, PREVENTING OVERHEATING OF THE TWC (THREE-WAY CATALYTIC CONVERTER) AND REDUCING HC AND CO EMISSIONS. THE ENGINE CONTROL MODULE (ECU) EVALUATES THE SIGNALS FROM EACH SENSOR (INPUT SIGNALS (1, 4, 5, 6, 7, 9, 11)), THEN SENDS OUTPUT TO **TERMINAL AS** AND CONTROLS THE VSV.

* EGR CUT CONTROL SYSTEM

THE EGR CUT CONTROL SYSTEM CONTROLS THE VSV (FOR EGR) BY EVALUATING THE SIGNALS FROM EACH SENSOR INPUT TO THE ENGINE CONTROL MODULE (ECU) (INPUT SIGNALS (1, 9)) AND BY SENDING OUTPUT TO **TERMINAL EGR** OF THE ENGINE CONTROL MODULE (ECU).

3. DIAGNOSIS SYSTEM

WITH THE DIAGNOSIS SYSTEM, WHEN THERE IS A MALFUNCTION IN THE ENGINE CONTROL MODULE (ECU) SIGNAL SYSTEM, THE MALFUNCTIONING SYSTEM IS RECORDED IN THE MEMORY. THE MALFUNCTIONING SYSTEM CAN THEN BE FOUND BY READING THE DISPLAY (CODE) OF THE MALFUNCTION INDICATOR LAMP (CHECK ENGINE WARNING LIGHT).

4. FAI-SAFE SYSTEM

WHEN A MALFUNCTION OCCURS IN ANY SYSTEM, IF THERE IS A POSSIBILITY OF ENGING TROUBLE BEING CAUSED BY CONTINUED CONTROL BASED ON THE SIGNALS FROM THAT SYSTEM, THE FAIL-SAFE SYSTEM EITHER CONTROLS THE SYSTEM BY USING DATA (STANDARD VALUES) RECORDED IN THE ENGINE CONTROL MODULE (ECU) MEMORY OR ELSE STOPS THE ENGINE.

ENGINE CONTROL (3VZ-E)

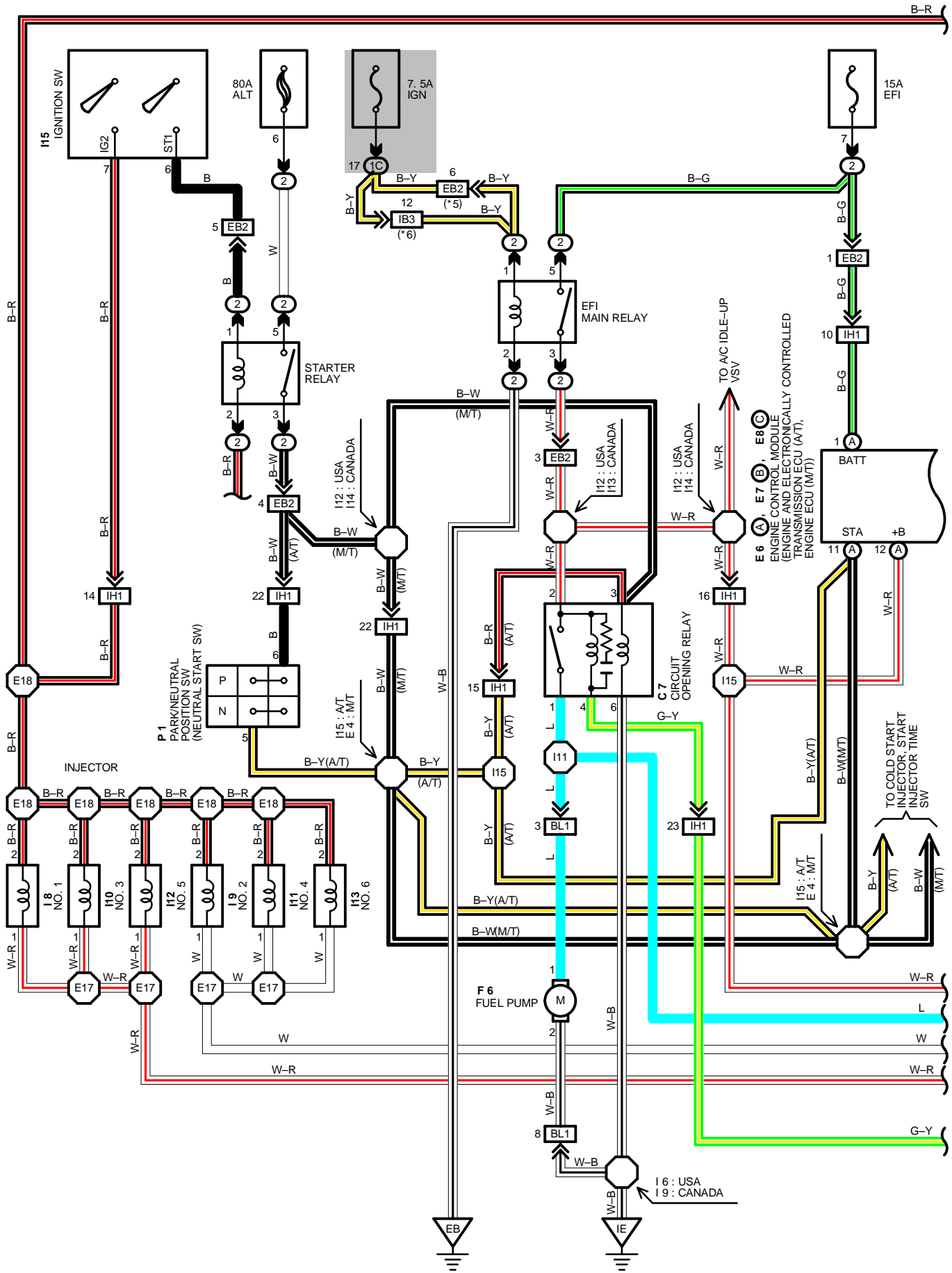

*1 : MALFUNCTION INDICATOR LAMP (CHECK ENGINE)
 *2 : VEHICLE SPEED SENSOR (SPEED SENSOR)

*3 : W/ CRUISE CONTROL
 *4 : W/O CRUISE CONTROL

*5 : REAR WHEEL ABS
 *6 : 4 WHEEL ABS

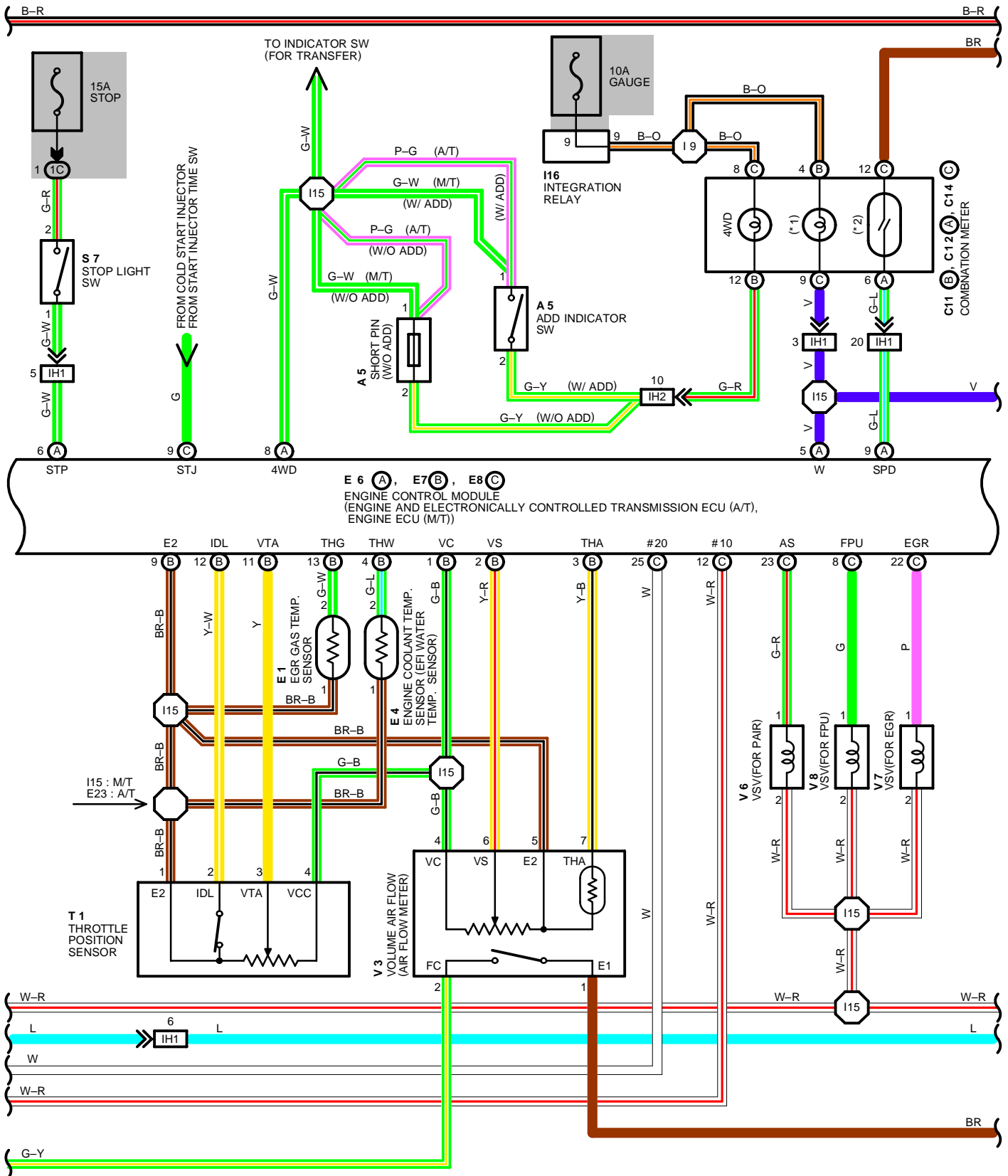

SERVICE HINTS

EFI MAIN RELAY

(2) 5–(2) 3: CLOSED WITH IGNITION SW AT ON OR ST POSITION

V 3 VOLUME AIR FLOW (AIR FLOW METER)

1–2: CLOSED WITH STARTER RUNNING OR MEASURING PLATE OPEN

4–5: **200–400 Ω**

5–6: **200–600 Ω** (MEASURING PLATE FULLY CLOSED)

20–1200 Ω (MEASURING PLATE FULLY OPEN)

5–7: **10–20 KΩ** (–20° C, –4° F)

4–7 KΩ (0° C, 32° F)

2–3 KΩ (20° C, 68° F)

0.9–1.3 KΩ (40° C, 104° F)

0.4–0.7 KΩ (60° C, 140° F)

C 7 CIRCUIT OPENING RELAY

1–2: CLOSED WITH STARTER RUNNING OR MEASURING PLATE (AIR FLOW METER) OPEN

I 8, I 9, I 10, I 11, I 12, I 13 INJECTOR

1–2: APPROX. **13.8 Ω**

P 1 PARK/NEUTRAL POSITION SW (NEUTRAL START SW) (A/T)

6–5: CLOSED WITH A/T SHIFT LEVER IN P OR N POSITION

T 1 THROTTLE POSITION SENSOR

3–1: **0.47–6.1 KΩ** WITH CLEARANCE BETWEEN LEVER AND STOP SCREW **0 MM (0 IN.)**

2–1: **2.3 KΩ** OR LESS WITH CLEARANCE BETWEEN LEVER AND STOP SCREW **0.50 MM (0.0197 IN.)**

INFINITY WITH CLEARANCE BETWEEN LEVER AND STOP SCREW **0.77 MM (0.0303 IN.)**

3–1: **3.1–12.1 KΩ** WITH THROTTLE VALVE FULLY OPEN

4–1: **3.9–9.0 KΩ**

E 4 ENGINE COOLANT TEMP. SENSOR (EFI WATER TEMP. SENSOR)

1–2: **10–20 KΩ** (–20° C, –4° F)

4–7 KΩ (0° C, 32° F)

2–3 KΩ (20° C, 68° F)

0.9–1.3 KΩ (40° C, 104° F)

0.4–0.7 KΩ (60° C, 140° F)

0.2–0.4 KΩ (80° C, 176° F)

E 6(A), E 7(B), E 8(C) ENGINE CONTROL MODULE (ENGINE AND ELECTRONICALLY CONTROLLED TRANSMISSION ECU (A/T), ENGINE ECU (M/T))

VOLTAGE AT ENGINE CONTROL MODULE (ECU) CONNECTORS

+B –E1: 9.0–14.0 VOLTS (IGNITION SW ON)

BATT –E1: 9.0–14.0 VOLTS (ALWAYS)

VC –E2: 4.5–5.5 VOLTS (IGNITION SW ON)

IDL –E2: 9.0–14.0 VOLTS (IGNITION SW ON AND THROTTLE VALVE OPEN)

VTA –E2: 0.3–0.8 VOLTS (IGNITION SW ON AND THROTTLE VALVE FULLY CLOSED)

3.2–4.9 VOLTS (IGNITION SW ON AND THROTTLE VALVE FULLY OPEN)

IGT –E1: PULSE GENERATION (ENGINE IDLING)

STA –E1: 6.0 VOLT OR MORE (ENGINE CRANKING)

#10, #20 –E1: 9.0–14.0 VOLTS (IGNITION SW ON)

W –E1: 9.0–14.0 VOLTS (NO TROUBLE AND ENGINE RUNNING)

VS –E2: 4.0–5.5 VOLTS (IGNITION SW ON AND MEASURING PLATE FULLY CLOSED)

THA –E2: 0.5–3.4 VOLTS (IGNITION SW ON AND INTAKE AIR TEMP. **0° C (32° F) –80° C (176° F)**)

THW –E2: 0.2–1.0 VOLTS (IGNITION SW ON AND COOLANT TEMP. **60° C (140° F) –120° C (248° F)**)

STP –E1: 7.5–14.0 VOLTS (STOP LIGHT SW ON)

RESISTANCE AT ENGINE CONTROL MODULE (ECU) WIRING CONNECTOR

(DISCONNECT WIRING CONNECTOR)

IDL –E2: INFINITY (THROTTLE VALVE OPEN)

0–100 Ω (THROTTLE VALVE FULLY CLOSED)

VTA –E2: 3.3–10 KΩ (THROTTLE VALVE FULLY OPEN)

0.2–0.8 KΩ (THROTTLE VALVE FULLY CLOSED)

THA –E2: 2–3 KΩ (INTAKE AIR TEMP. **20° C, 68° F**)

THW –E2: 0.2–0.4 KΩ (COOLANT TEMP. **80° C, 178° F**)

VS –E2: 0.02–0.1 KΩ (MEASURING PLATE FULLY CLOSED)

0.02–1.0 KΩ (MEASURING PLATE FULLY OPEN)

NE –E1: 140–180 KΩ

+B –E2: 0.2–0.4 KΩ

STJ –E1: INFINITY

ENGINE CONTROL (3VZ-E)

○ : PARTS LOCATION

CODE	SEE PAGE	CODE	SEE PAGE	CODE	SEE PAGE
A 5	24 (3VZ-E)	E 8	C 28	I15	28
A11	28	F 6	29	I16	28
C 7	28	H 3	24 (3VZ-E)	K 1	25 (3VZ-E)
C11	B 28	H10	24 (3VZ-E)	P 1	25 (3VZ-E)
C12	A 28	I 1	25 (3VZ-E)	S 7	28
C14	C 28	I 2	25 (3VZ-E)	T 1	25 (3VZ-E)
D 1	24 (3VZ-E)	I 8	25 (3VZ-E)	V 3	25 (3VZ-E)
D 3	24 (3VZ-E)	I 9	25 (3VZ-E)	V 6	25 (3VZ-E)
E 1	24 (3VZ-E)	I 10	25 (3VZ-E)	V 7	25 (3VZ-E)
E 4	24 (3VZ-E)	I 11	25 (3VZ-E)	V 8	25 (3VZ-E)
E 6	A 28	I 12	25 (3VZ-E)		
E 7	B 28	I 13	25 (3VZ-E)		

○ : RELAY BLOCKS

CODE	SEE PAGE	RELAY BLOCKS (RELAY BLOCK LOCATION)
2	22	R/B NO. 2 (ENGINE COMPARTMENT RIGHT)

○ : JUNCTION BLOCK AND WIRE HARNESS CONNECTOR

CODE	SEE PAGE	JUNCTION BLOCK AND WIRE HARNESS (CONNECTOR LOCATION)
1C	20	COWL WIRE AND J/B NO. 1 (LEFT KICK PANEL)

□ : CONNECTOR JOINING WIRE HARNESS AND WIRE HARNESS

CODE	SEE PAGE	JOINING WIRE HARNESS AND WIRE HARNESS (CONNECTOR LOCATION)
EB2	30 (3VZ-E)	COWL WIRE AND ENGINE ROOM MAIN WIRE (R/B NO. 2)
ED1	30 (3VZ-E)	SENSOR WIRE AND ENGINE WIRE (ON THE HEAD COVER)
IB3	34	ENGINE ROOM MAIN WIRE AND COWL WIRE (LEFT KICK PANEL)
IG1	34	COWL WIRE AND A/C WIRE (BEHIND GLOVE BOX)
IH1	34	ENGINE WIRE AND COWL WIRE (RIGHT KICK PANEL)
IH2		
BL1	36	FRAME NO. 2 WIRE AND COWL WIRE (UNDER THE FRONT LH SEAT)

▽ : GROUND POINTS

CODE	SEE PAGE	GROUND POINTS LOCATION
EB	30 (3VZ-E)	LEFT FENDER
EC	30 (3VZ-E)	RH CYLINDER HEAD COVER REAR
IE	34	LEFT KICK PANEL

○ : SPLICE POINTS

CODE	SEE PAGE	WIRE HARNESS WITH SPLICE POINTS	CODE	SEE PAGE	WIRE HARNESS WITH SPLICE POINTS
E 4	30 (3VZ-E)	ENGINE WIRE	I 6	34	COWL WIRE
E17			I 9		
E18			I11		
E23			I12	34	COWL WIRE
E24			I13		
E25			I14		
E27			I15		

A 5 DARK GRAY



A11

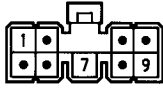

C 7 DARK GRAY

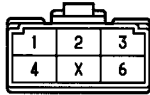

C11 (B) BLUE

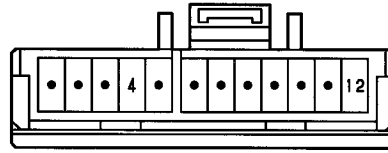

C12 (A)

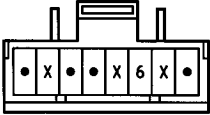

C14 (C)

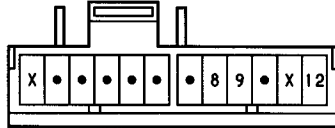

D 1 DARK GRAY

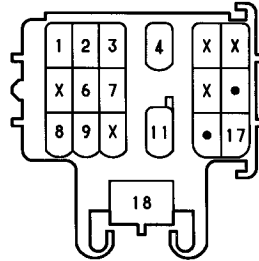

D 3 BLACK



E 1 DARK GRAY



E 4 DARK GRAY



E 6 (A) DARK GRAY

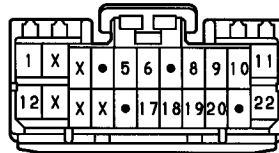

E 7 (B) DARK GRAY

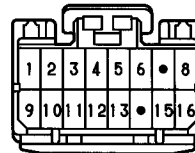

E 8 (C) DARK GRAY

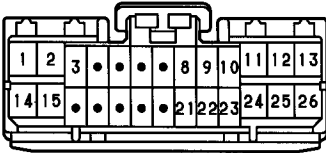

F 6 DARK GRAY



H 3, H10 DARK GRAY



I 1 BLACK



I 2 BLACK

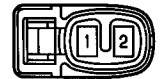

I 8, I 9, I10, BLUE
I12, I13



I11 GRAY



I15 BLACK

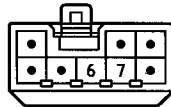

I16

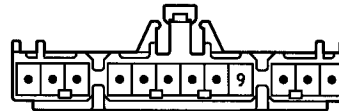

K 1 DARK GRAY



P 1 GRAY

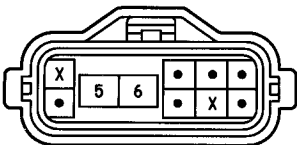

(W/ CRUISE S 7 CONTROL)

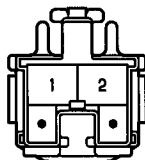

(W/O CRUISE S 7 BLACK CONTROL)

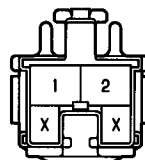

T 1 BLACK



V 3 BLACK



V 6 BLUE



V 7 GREEN



V 8 BROWN

